

Mohan's Precast USA, Inc.

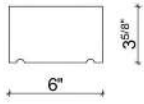

Side view

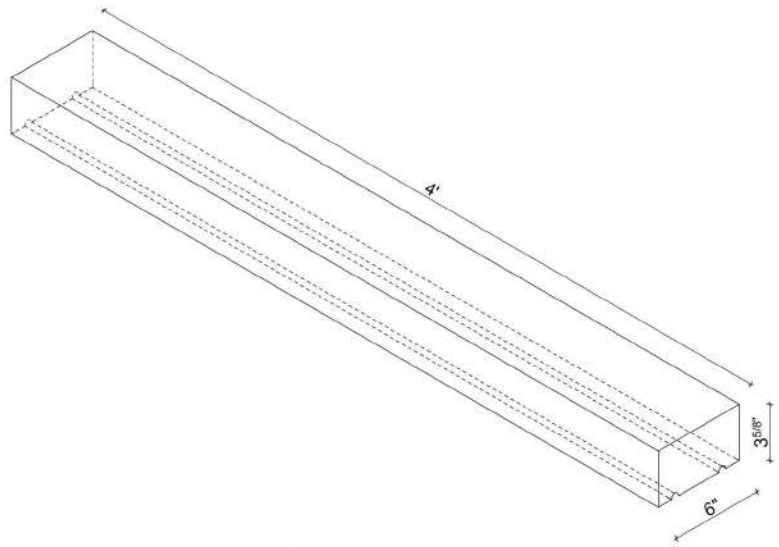

Isometric view

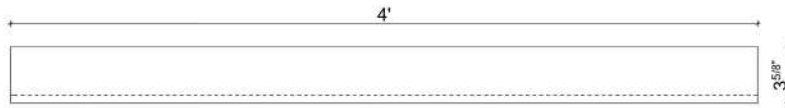

Front view

Qty:

(Color may vary)

(Standard length 48")



Product ID: SQWDSL48

Date:

Client:

Project:

Approved by:

Color: White
 Buff
 Gray
 Custom

Texture: Smooth
 Light Etch
 Heavy Etch

Precast
 Cast Stone
 Limestone